

Reliance Femoral Component

Surgical Technique

Using the Command Express
Instrument System



Reliance Femoral Component Surgical Protocol

Using the Command Express Instrument System

Technique Options

The Command Express Instrument System is extremely versatile, offering surgeons great flexibility in approaching the implantation of the Reliance Femoral Component. This publication presents a basic technique, followed by *Technique Options at-a-Glance*, an overview of the system.

Pre-operative Templating

The Reliance Hip System offers a complete set of femoral templates. All templates are at 120% magnification.

Acetabular Options

Stryker offers a wide variety of acetabular components that are compatible with the Reliance Femoral Component. The surgeon should refer to a specific acetabular component's surgical technique for a discussion of acetabular surgical procedures.

Surgical Approach

Each surgeon should use the surgical approach for total hip arthroplasty with which he/she is most familiar. Patient positioning, prepping and draping, the skin incision, soft tissue dissection, and hip dislocation are performed according to the surgeon's preferred technique, making certain to adequately expose the acetabulum and the proximal femur.

Indications

- Noninflammatory degenerative joint disease, including osteoarthritis and avascular necrosis;
- Rheumatoid arthritis;
- Correction of functional deformity;
- Revision procedures where other treatments or devices have failed; and,
- Treatment of nonunions, femoral neck fractures, and trochanteric fractures of the proximal femur with head involvement that are unmanageable using other techniques.

Contraindications

- Active infection or suspected latent infection in or about the hip joint;
- Bone stock that is inadequate for support or fixation of the prosthesis;
- Skeletal immaturity;
- Any mental or neuromuscular disorder that would create an unacceptable risk of prosthesis instability, prosthesis fixation failure, or complications in post-operative care.

Warning and Precautions

See package insert warning, precautions, adverse effects and other essential product information.

Acknowledgements

The Partnership System, which includes the Reliance Femoral Components and the Command Instruments, is a collaboration between Stryker and a group of orthopaedic surgeons and biomedical design engineers. This team has developed an integrated series of implants and instruments designed to address the needs of patients, surgeons, and O.R. staff in today's changing healthcare environment. The design group includes:

Lester S. Borden, MD

Retired Head
Adult Reconstructive Orthopaedic Surgery
Cleveland Clinic, Cleveland, OH

Edward T. Habermann, MD†

Anthony K. Hedley, MD, FRCS

President
Arizona Institute of Bone & Joint Disorders
Phoenix, AZ

David S. Hungerford, MD

Professor of Orthopaedic Surgery
Johns Hopkins University, Baltimore, MD
Good Samaritan Hospital, Baltimore, MD

Kenneth A. Krackow, MD

Professor of Orthopaedic Surgery
State University of New York at Buffalo
Department Head
Department of Orthopaedic Surgery
Buffalo General Hospital, Buffalo, NY

Roger N. Levy, MD*

Joseph C. McCarthy, MD
Director, Center for Joint
Reconstruction Surgery
Newton Wellesley Hospital, Boston, MA
Vice Chair for Program Development,
Orthopaedic Surgery
Massachusetts General Hospital,
Boston, MA

Philip C. Noble, PhD

Dunn Professor of Orthopedic Research
The Methodist Hospital, Houston, TX

Hugh S. Tullos, MD†

Roderick H. Turner, MD*

† Deceased

* Retired

This publication sets forth recommended procedures for using Stryker devices and instruments. It offers guidance that you should heed, but, as with any such technical guide, each surgeon must consider the particular needs of each patient and make appropriate adjustments when and as required.

Reliance Femoral Component Surgical Protocol

Starting†

1 Determine and Mark the Osteotomy Level

By using anatomic landmarks identified during templating, the osteotomy guide identifies the location of the osteotomy cut. The osteotomy guide has several features to assist the surgeon (**Figure 1**):

- **[A]** Long tail of the osteotomy guide for alignment with the femoral shaft axis.
- **[B]** Notch in the proximal portion of the guide references the proximal tip of the greater trochanter.
- **[C]** Neck resection level.

Care must be taken to restore proper leg length by referencing the osteotomy level back to the center of rotation of the implanted acetabular component.

The resection level should be about a fingerbreadth above the lesser trochanter. An angled surface provides a plane for marking the level of the cut, or can be used as a cutting surface for the sawblade.

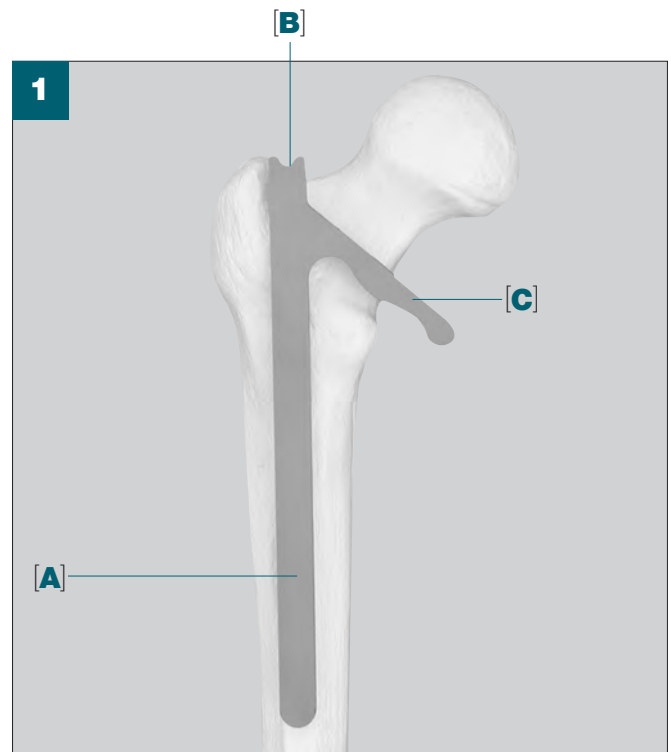

2 Perform Osteotomy

A 40° osteotomy angle allows a single cut across the neck, and generally eliminates the need for a second cut to complete the resection (**Figure 2**).



†Additional options available; see Appendix 2, page 15.

3 Open and Size the Canal with Starter Awl

The tapered starter awl is a hand-operated instrument designed to open the femoral canal and indicate distal diameter size. Assemble *small* hex T-handle onto starter/sizer awl, and target piriformis fossa to open canal. Progress the awl distally until some cortical resistance is achieved. Use aggressive cutting teeth of starter awl to achieve lateralization (Figure 3).

For additional reaming options see Appendix 2; page 16.



4 Depth of Starter Awl

Make note of millimeter diameter marking [A] that appears at the medial osteotomy level (Figure 4). These marking grooves on shaft identify distal diameter sizing of femoral canal.

Reliance CM Stem Size	Minimum Distal Canal Diameter Required
1	11mm
2	12mm
3	13mm
4	14mm
5	15mm

Reliance PF Stem Size	Minimum Distal Canal Diameter Required
0	10mm
1	11mm
2	12mm
3	13mm
4	14mm
5	15mm
6	16mm
7	17mm

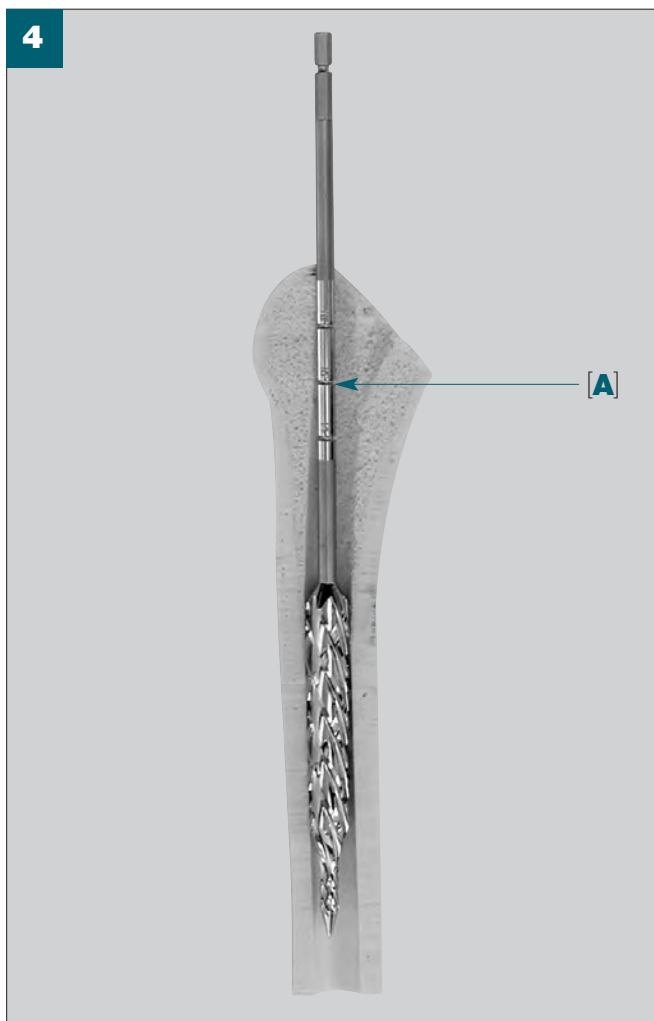

Reliance Femoral Component Surgical Protocol

Broaching

5 Select Fully Toothed Broach

There are two styles of broaches available: *Fully Toothed* and *Universal*. The Fully Toothed broach is featured here (Figure 5). Select a broach one size smaller than the anticipated implant size, based on pre-operative templating. Attach handle to broach by inserting trunnion of the broach into broach handle and turning the locking knob in the direction indicated (Figure 5).

Reliance CM*/PF Stem Size	Fully Toothed Broach Size
0	0
1	1
2	2
3	3
4	4
5	5
6	6
7	7

* Reliance CM available in stem sizes 1-5 only.

If the Universal Broach is selected then reaming is essential.

6 Introduce Broach

Introduce broach into proximal femur. Drive the broach down the canal with a mallet, keeping it aligned with the neutral femoral axis. *Assess fit and resistance to movement.* If a larger size is needed, remove the broach and replace it with the next largest size. To facilitate final seating of the broach, partially withdraw the broach to clear cutting teeth of bone; then re-introduce the instrument into the canal (Figure 6).

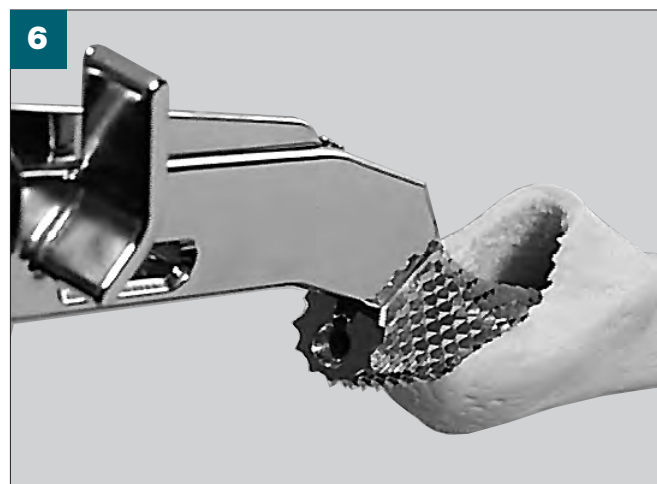
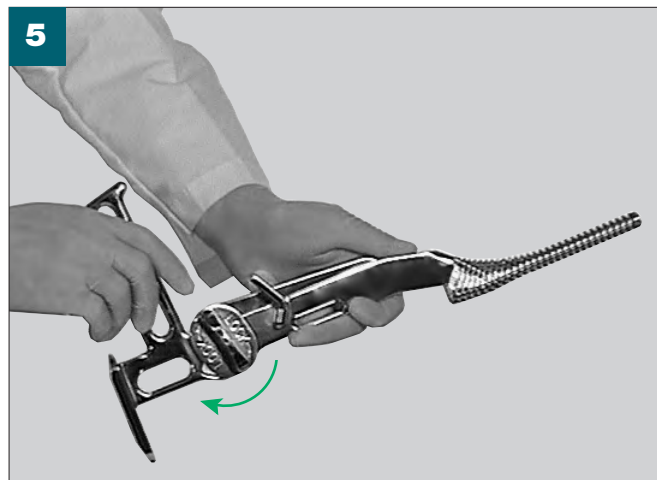

7 Calcar Planer

Leave the final broach seated in the canal. Remove the broach handle. The broach trunnion may be used as a guide for the calcar planer. The calcar planers come in two sizes: standard and large. Select the proper size planer and assemble it to the power adaptor. The female bushing on the planer is guided over the broach trunnion (**Figure 7**). The medial calcar should be leveled to aid the collar calcar contact.



8 Fit Neck Trial to Trunnion

Select the appropriate size V40 neck trial corresponding to the broach/implant size and push the trunnion securely onto the broach (**Figure 8**).

To prepare the femur for the Reliance CM Stem using a cemented procedure proceed to Step 9C on page 8.

To prepare the femur for the Reliance PF Stem using a press-fit procedure proceed to Step 9PF on page 10.

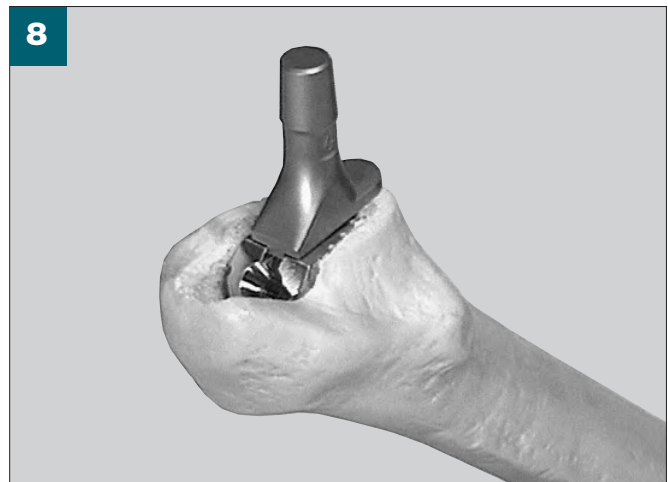

Reliance Femoral Component Surgical Protocol

Reliance CM Completion

See pages 10 & 11 for surgical implantation of the Reliance PF (press-fit) implant.

Reliance CM is designed for cemented applications.

To complete the surgery with a Reliance CM implant the following steps (9C thru 13C) should be followed:

9C Trial Reduction

Select the head diameter [26mm, 28mm, 32mm, 36mm, 40mm or 44mm] according to surgeon preference. The V40 head trials have a circumferential groove which identifies the level of the center of rotation. Select the femoral head offset option* based on pre-operative templating. Attach the head trial to the neck trial and perform a trial reduction, assessing the hip for stability, leg length, and overall range of motion. Remove the broach and all trials.

*Femoral Head offset options may vary depending on diameter size and material composition.



10C Insert Cement

Thoroughly clean and dry the canal. Insert a bone plug to a level 2cm distal to end of stem. Prepare the bone cement. Pump cement into the canal in retrograde fashion, retracting the nozzle as back pressure is felt (Figure 10C). When the canal is filled with cement, place the appropriate pressurizing seal in the mouth of femur. Slide the cement nozzle through the seal and introduce remaining cement under pressure. Retain a small bolus of bone cement to serve as guide to know when the cement in the canal has cured.

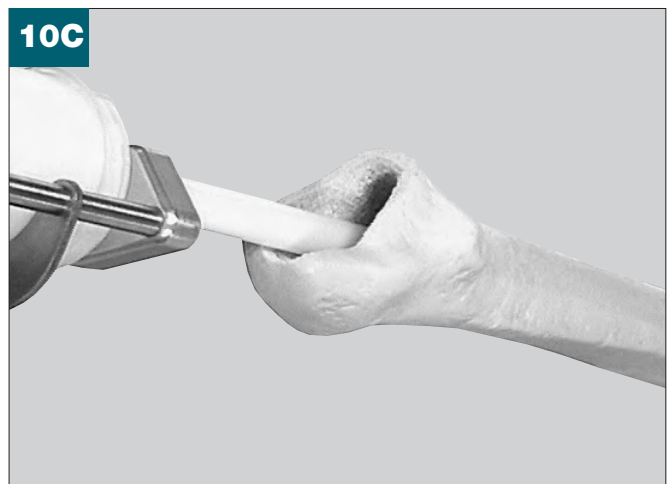

11C Assemble Introducer to Implant

Assemble the insertion tool to the implant that matches the last broach size seated. *Make sure that the distal tip of the instrument is correctly mated to the orientation keyway of the insertion feature of the implant.* For ease of assembly, hold hands as illustrated (**Figure 11C**), using the thumb to turn the locking knob. Fully and securely attach the instrument to the stem.

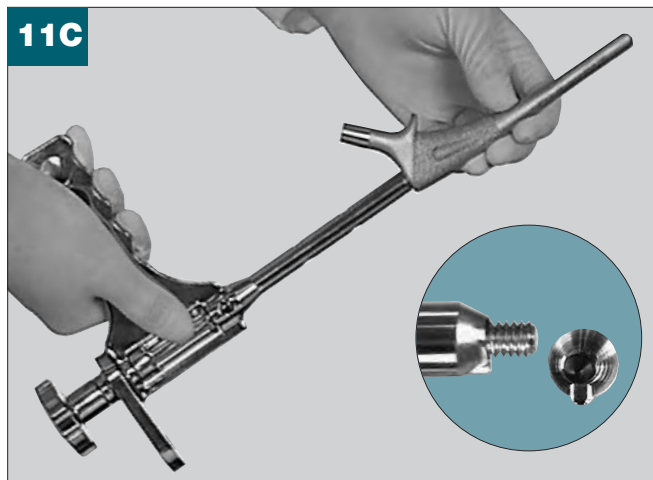

12C Select and Attach Distal Spacer

The correct size of the distal centralizer is determined by the diameter of the distal canal. Each centralizer will fit into the distal hole of any stem size and is held in place via taper lock (**Figure 12C**). The distal centralizer will aid in guiding the Reliance stem into neutral alignment during insertion.



13C Insert the Implant

Insert the implant keeping it aligned with the neutral femoral axis (**Figure 13C**). The handle can be used to control anteversion as you implant the prosthesis. Remove the inserter by turning the locking knob on the top of the stem inserter.

Proceed to Step 14 (page 11) to perform Final Assessment and Head Assembly.

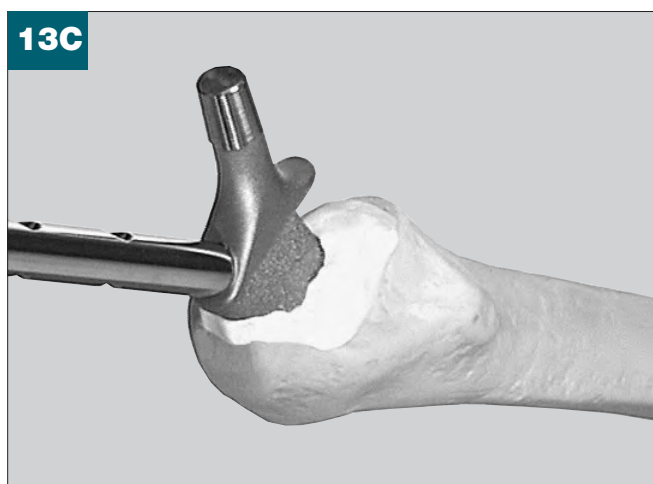

Reliance Femoral Component Surgical Protocol

Reliance PF Completion

See pages 8 & 9 for surgical implantation of the Reliance CM (cemented) implant.

Reliance PF is designed for press-fit applications. To complete the surgery with a Reliance PF implant the following steps (9PF thru 11PF) should be followed:

9PF Trial Reduction

Select the head diameter [26mm, 28mm, 32mm, 36mm, 40mm or 44mm] according to surgeon preference. The V40 head trials have a circumferential groove which identifies the level of the center of rotation. Select the femoral head offset option* based on pre-operative templating. Attach the head trial to the neck/collar trial and perform a trial reduction, assessing the hip for stability, leg length, and overall range of motion. Remove the broach and all trials.

*Femoral Head offset options may vary depending on diameter size and material composition.



10PF Assemble Introducer to Implant

Assemble the insertion tool to the implant that matches the last broach size seated. *Make sure that the distal tip of the instrument is correctly mated to the orientation keyway of the insertion feature of the implant.* For ease of assembly, hold hands as illustrated (Figure 10PF), using the thumb to turn the locking knob. Fully and securely attach the instrument to the stem.

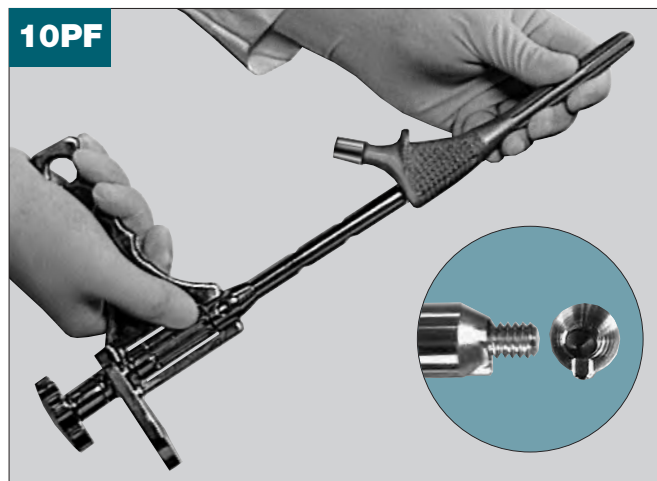

11PF Insert the Implant

Insert the implant keeping it aligned with the neutral femoral axis (Figure 11PF). The handle can be used to control anteversion as you implant the prosthesis. Remove the inserter by turning the locking knob on the top of the stem inserter. Proceed to Step 14 (page 11) to perform Final Assessment and Head Assembly.

Cemented Option: *The Reliance PF may also be cemented into the femur. The stem size must be reduced by one or two sizes to attain the desired cement mantle thickness. When cementing the Reliance PF, a distal centralizer must always be used, even if the centralizer diameter exactly matches the stem diameter.*

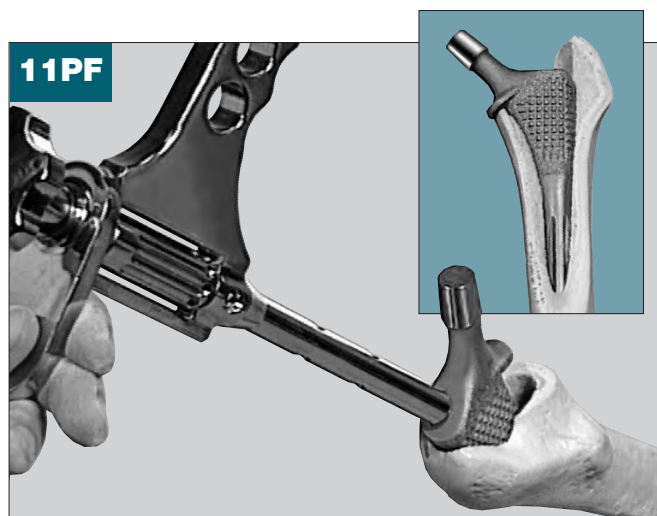

Final Assessment

14 Final Trial Reduction

Prior to head assembly, head offset selection may be re-evaluated using a Stryker V40 Trial Head. Place the Trial Head onto the stem neck taper and reduce the hip to verify that the mechanics have not been altered due to implant seating. (Figure 14).



15 Head Assembly

Remove the Trial Head and dry the implant trunnion with a laparotomy sponge or sterile towel.

Select the appropriate corresponding V40 Femoral Head size and place it onto the dry trunnion of the femoral stem with a slight twist. Impact the head with two moderate blows using the Femoral Head Impactor (Figure 15).

NOTE: Only Stryker V40 femoral heads labeled as 5° 40' taper may be used with the stems in the partnership system.

NOTE: The Reliance PF and CM stems can be used with either a V40 CoCr Femoral Head, a BIOLOX *delta* Femoral Head, a Biolox *delta* Universal Head and a V40 Universal Adaptor Sleeve, or a Titanium Adapter Sleeve and an Alumina Ceramic C-Taper Femoral Head.



Head Assembly (Continued)

Optional Step

NOTE: When selecting a BIOLOX *delta* Universal Taper Ceramic Femoral Head for implantation, use of a Universal Adaptor Sleeve is necessary.

After completing the trialing process, intra-operatively assemble the Adaptor Sleeve to the femoral stem manually.

The Universal Adaptor Sleeve must be fully seated on the stem taper before the head is assembled.

NOTE: In no instance should any attempt be made to pre-assemble the BIOLOX *delta* Universal Ceramic head.

Intra-operatively assemble the BIOLOX *delta* Universal Taper Ceramic head onto the sleeved femoral stem and set with one to three moderate blows using the Femoral Head Impactor. Care must be taken to avoid excessive impact forces when assembling the Ceramic Head to the sleeved femoral component.

Universal Adapter Sleeves

V40 Universal Adapter Sleeve Part Numbers	Offset	Stem Material Compatibility
6519-T-025	-2.5mm	TMZF, Ti6-4, CoCr
6519-T-100	+0	TMZF, Ti6-4, CoCr
6519-T-204	+4 mm	TMZF, Ti6-4, CoCr

16 Reduce Joint and Close

Relocate the femoral head into the acetabular cup and check the laxity and range of motion. The surgical site is then closed according to the surgeon's standard procedure for the surgical approach chosen.

Appendix 1: Implant Specifications

RELIANCE CM Femoral Component

Catalog Number	Stem Size	Stem Length	Minimum Distal Canal Diameter Required	Neck Angle
6265-3-111	#1	100mm	11mm	132°
6265-3-112	#2	115mm	12mm	
6265-3-113	#3		13mm	
6265-3-114	#4	125mm	14mm	
6265-3-115	#5		15mm	

Neck Length*

Stem Size	Short - 4mm	Standard 0mm	Medium +4mm	Long +8mm	X-Long +12mm
#1	27mm	31mm	35mm	39mm	43mm
#2	28mm	32mm	36mm	40mm	44mm
#3	30mm	34mm	38mm	42mm	46mm
#4	31mm	35mm	39mm	43mm	47mm
#5	33mm	37mm	41mm	45mm	49mm

Femoral Head Offset**

Stem Size	Short - 4mm	Standard 0mm	Medium +4mm	Long +8mm	X-Long +12mm
#1	31mm	34mm	37mm	40mm	43mm
#2	33mm	36mm	39mm	42mm	45mm
#3	37mm	40mm	43mm	46mm	49mm
#4	41mm	44mm	47mm	50mm	53mm
#5	44mm	47mm	50mm	53mm	56mm

This femoral hip stem is compatible only with Stryker V40 CoCr or Biolox *delta* Femoral Heads (labeled as 5°40' taper).

Use of a C-Taper Alumina Ceramic Femoral Head requires the use of a titanium sleeve adaptor.

* Heads available in 26mm, 28mm, 32mm, 36mm, 40mm and 44mm diameters.

** Femoral Head offsets vary by head diameter and material composition.

Reliance Femoral Component Surgical Protocol

Appendix 1 (Continued)

RELIANCE PF Femoral Component

Catalog Number	Stem Size	Stem Length	Minimum Distal Canal Diameter Required	Neck Angle
6265-2-000	#0	115mm	10mm	132°
6265-2-001	#1		11mm	
6265-2-002	#2	130mm	12mm	
6265-2-003	#3		13mm	
6265-2-004	#4	140mm	14mm	
6265-2-005	#5		15mm	
6265-2-006	#6	150mm	16mm	
6265-2-007	#7		17mm	

Neck Length*

Stem Size	Short -4mm	Standard 0mm	Medium +4mm	Long +8mm	X-Long +12mm
#0	27mm	31mm	35mm	39mm	43mm
#1	27mm	31mm	35mm	39mm	43mm
#2	28mm	32mm	36mm	40mm	44mm
#3	30mm	34mm	38mm	42mm	46mm
#4	31mm	35mm	39mm	43mm	47mm
#5	33mm	37mm	41mm	45mm	49mm
#6	33mm	37mm	41mm	45mm	49mm
#7	35mm	39mm	43mm	47mm	51mm

Femoral Head Offset**

Stem Size	Short -4mm	Standard 0mm	Medium +4mm	Long +8mm	X-Long +12mm
#0	31mm	34mm	37mm	40mm	43mm
#1	31mm	34mm	37mm	40mm	43mm
#2	33mm	36mm	39mm	42mm	45mm
#3	37mm	40mm	43mm	46mm	49mm
#4	41mm	44mm	47mm	50mm	53mm
#5	44mm	47mm	50mm	53mm	56mm
#6	47mm	50mm	53mm	56mm	59mm
#7	49mm	52mm	55mm	58mm	61mm

This femoral hip stem is compatible only with Stryker V40 CoCr or BioloX *delta* Femoral Heads (labeled as 5°40' taper).

Use of a C-Taper Alumina Ceramic Femoral Head requires the use of a titanium sleeve adaptor.

* Heads available in 26mm, 28mm, 32mm, 36mm, 40mm and 44mm diameters.

** Femoral Head offsets vary by head diameter and material composition.

Recommended Technique

Appendix 2

Technique Options at-a-Glance

The Command Express Instrument System offers great flexibility when approaching implantation of the Reliance Femoral Component.

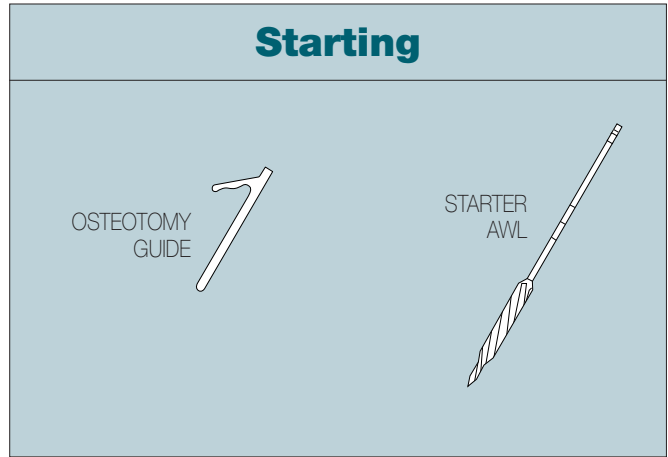

Additional Options

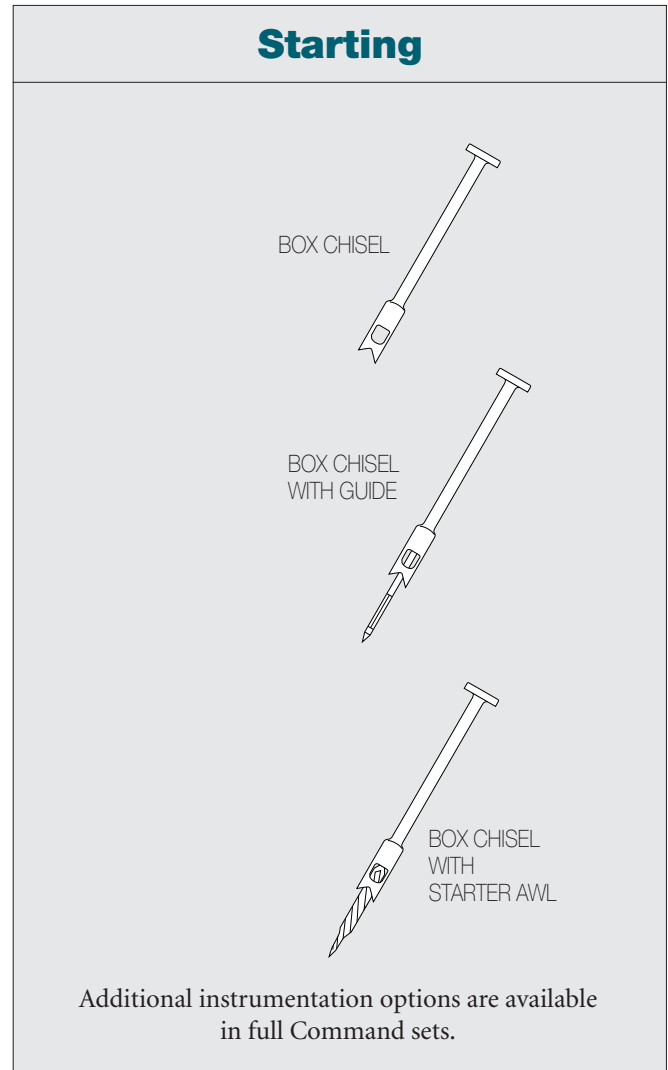

Command Express
Instrument System

Reliance Femoral Component Surgical Protocol

using **Command Express**

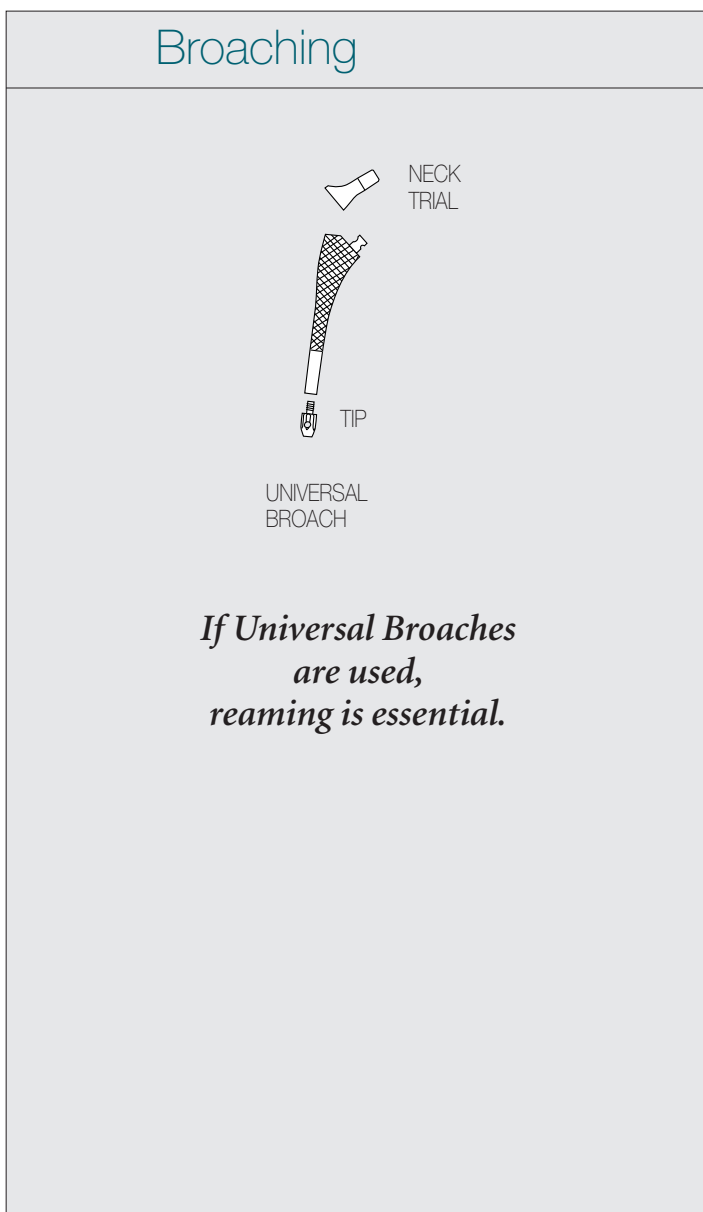
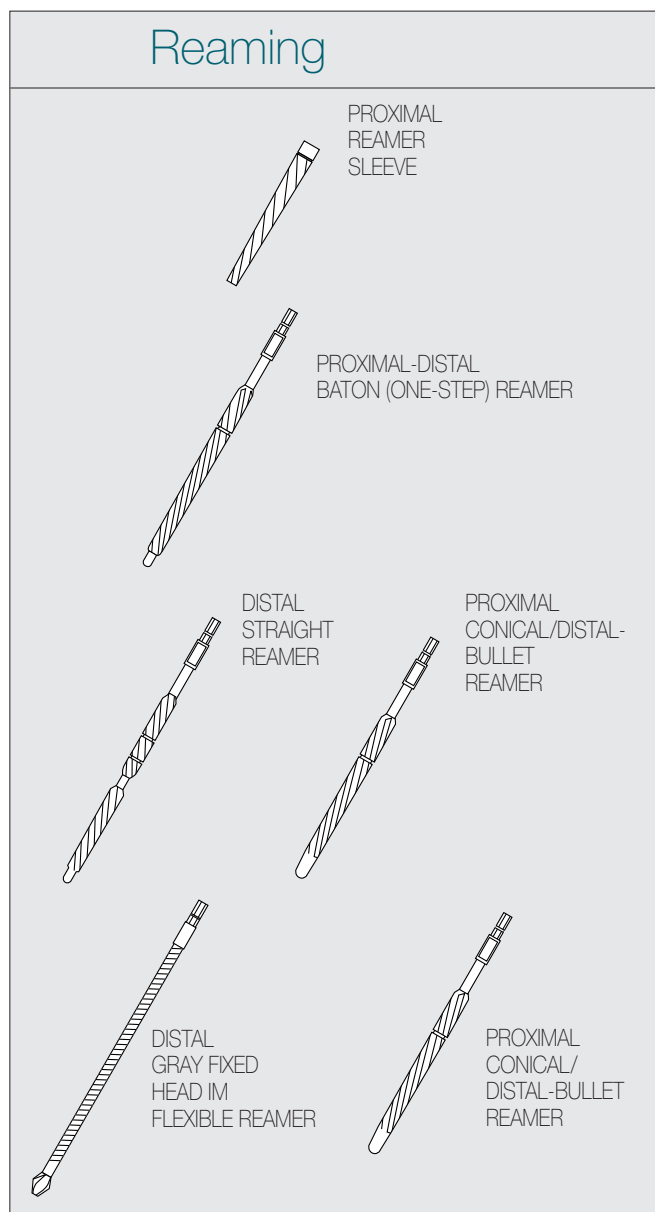
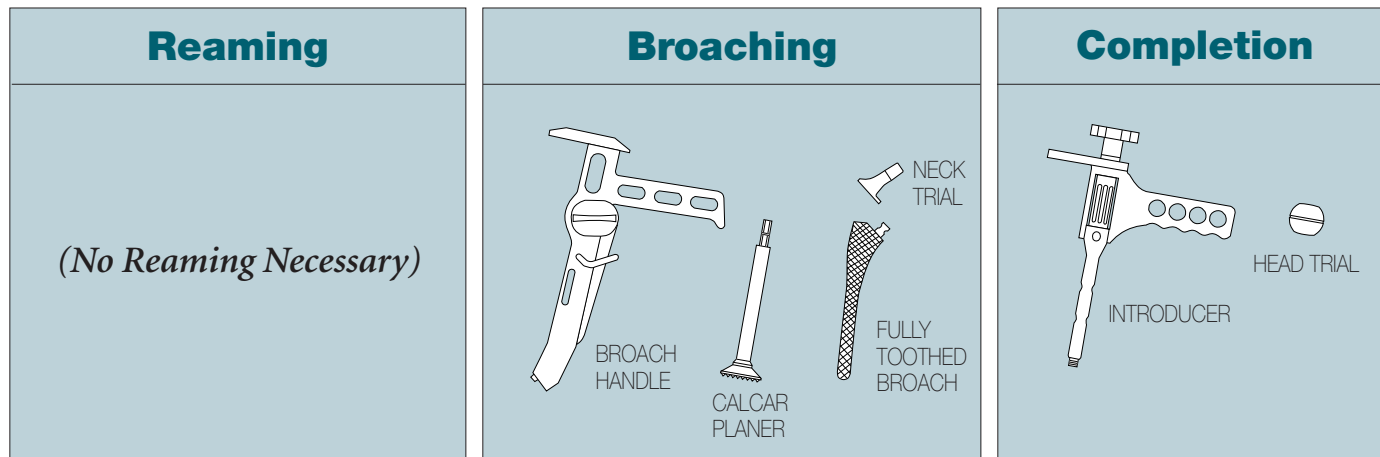

Joint Replacements

Trauma, Extremities & Deformities

Craniomaxillofacial

Spine

Biologics

Surgical Products

Neuro & ENT

Interventional Spine

Navigation

Endoscopy

Communications

Imaging

Patient Care & Handling Equipment

EMS Equipment

325 Corporate Drive
Mahwah, NJ 07430
t: 201 831 5000

www.stryker.com

A surgeon must always rely on his or her own professional clinical judgment when deciding whether to use a particular product when treating a particular patient. Stryker does not dispense medical advice and recommends that surgeons be trained in the use of any particular product before using it in surgery.

The information presented is intended to demonstrate the breadth of Stryker product offerings. A surgeon must always refer to the package insert, product label and/or instructions for use before using any Stryker product. Products may not be available in all markets because product availability is subject to the regulatory and/or medical practices in individual markets. Please contact your Stryker representative if you have questions about the availability of Stryker products in your area.

Stryker Corporation or its divisions or other corporate affiliated entities own, use or have applied for the following trademarks or service marks: Biolog delta, Command, Gray, Partnership, Reliance, Stryker and V40. All other trademarks are trademarks of their respective owners or holders.

Literature Number: LRCMST Rev. 1
MS/GS 04/10

Copyright © 2010 Stryker
Printed in USA